

Alternative Bracket locations

**SUBASSEMBLY KEY**  
**1 - DISPLAY MODULE- Refer to Sheet 2**  
**2 - POWER SUPPLY UNIT - Refer to sheet 3**

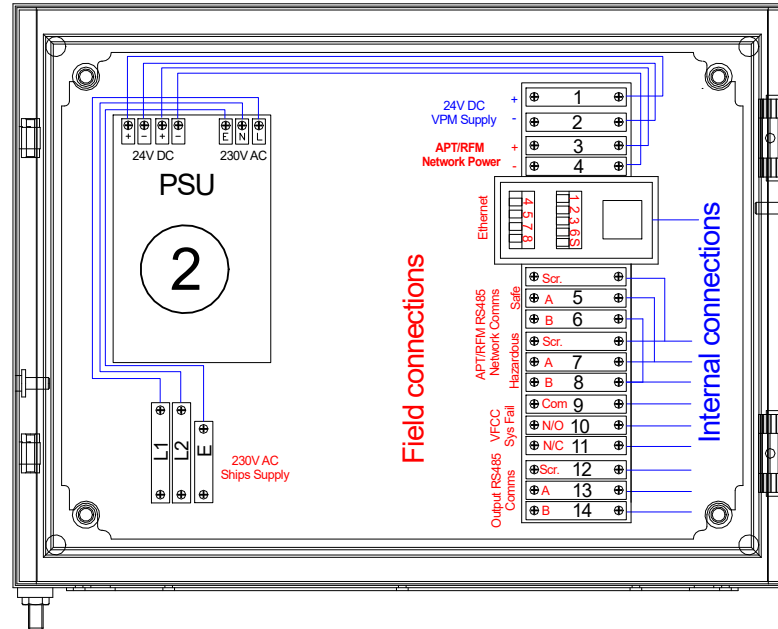

SCALE  
NTS  
FINISH

MATERIAL AND SPECIFICATION

ALL DIMENSIONS ARE IN MILLIMETERS  
UNLESS OTHERWISE STATED  
TOLERANCES UNLESS OTHERWISE STATED  
+/-0.1  
ANG +/2

ISSUE	A
DATE	09-03-21
TCR	
DRAWN	MJ
CHECKED	SL



**INSTRUMENTATION LTD**

PART OF THE **scanjet** GROUP

TITLE  
Wall mounting VPM 4315  
General Assembly

DRAWING No  
S-1509-VPM-GA

SALES DRAWING ONLY

SHT 1  
OF 3

**A4**

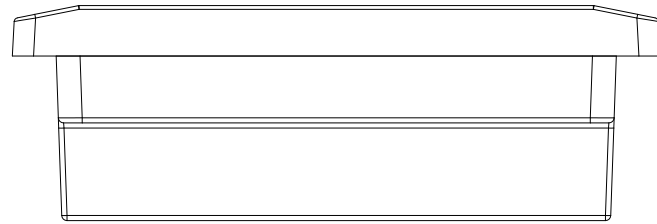

**TOP VIEW**

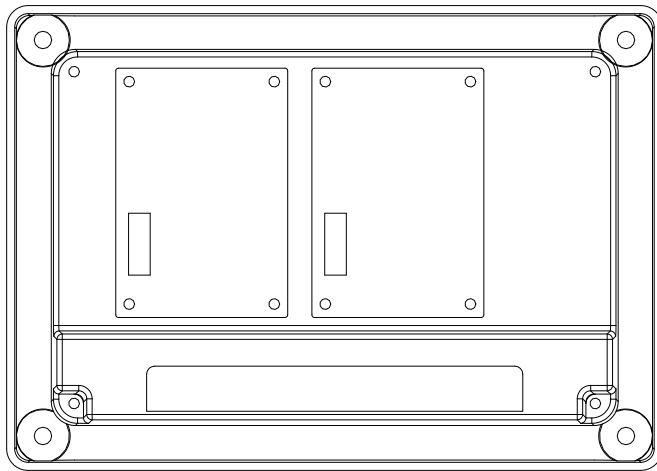

**REAR VIEW**

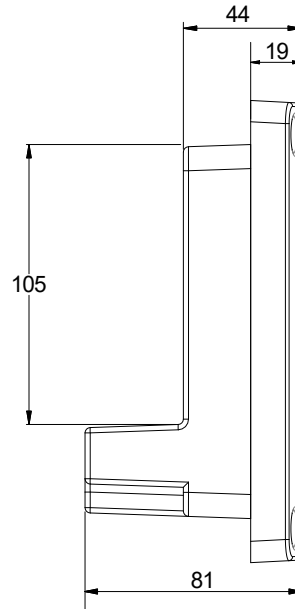

**SIDE VIEW**

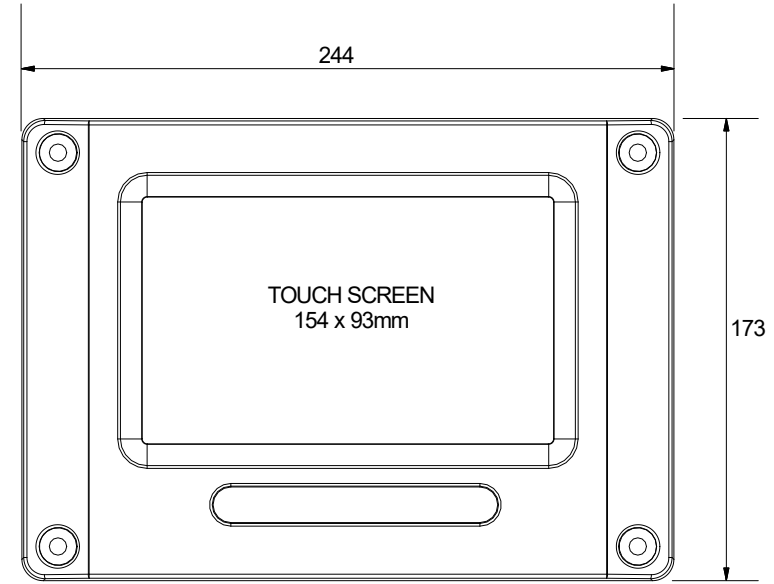

**FRONT VIEW**

SCALE  
NTS  
FINISH

MATERIAL AND SPECIFICATION

ALL DIMENSIONS ARE IN MILLIMETERS  
UNLESS OTHERWISE STATED  
TOLERANCES UNLESS OTHERWISE STATED  
+/-0.1  
ANG +/2

ISSUE	A
DATE	09-03-21
TCR	
DRAWN	MJ
CHECKED	SL

SHT 2  
OF 3

**A4**



**INSTRUMENTATION LTD**

PART OF THE  GROUP

TITLE

Wall mounting VPM 4315  
General Assembly

DRAWING No

S-1509-VPM-GA

**SALES DRAWING ONLY**

Fixing holes  
(mount via existing bracket)

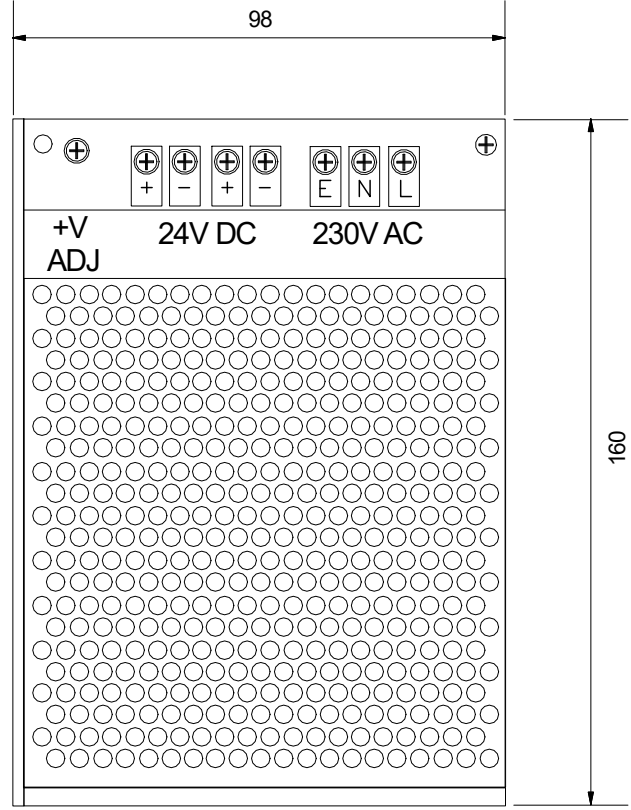
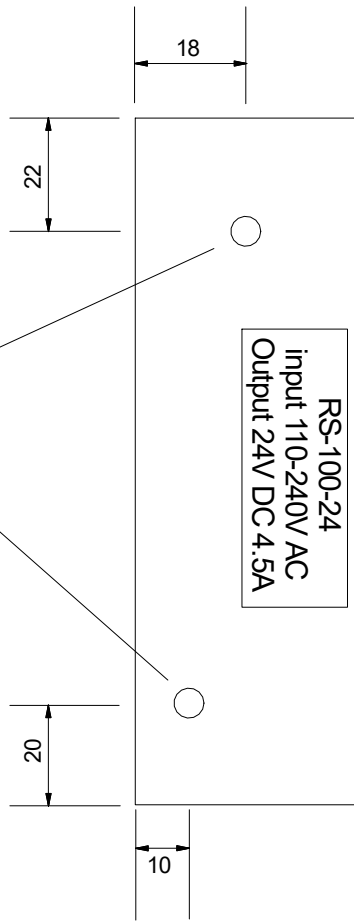

SCALE	NTS	FINISH
MATERIAL AND SPECIFICATION		
ALL DIMENSIONS ARE IN MILLIMETERS UNLESS OTHERWISE STATED TOLERANCES UNLESS OTHERWISE STATED +/-0.1 ANG +/-2		
ISSUE	A	09-03-21
DATE		
TCR		
DRAWN		MJ
CHECKED		SL



**INSTRUMENTATION LTD**  
PART OF THE **scanjet** GROUP

TITLE  
Wall mounting VPM 4315  
General Assembly

DRAWING No  
S-1509-VPM-GA  
SALES DRAWING ONLY

SHT 3  
OF 3  
**A4**